

STAMP

PRELIMINARY
NOT FOR
CONSTRUCTION

REVISION	DATE	DESCRIPTION

JOB No.: 2200512
DESIGNED BY: DLG/AB
DRAWN BY: DLG
CHECKED BY: AB
PLOT DATE: 4/25/23 10:39am
PLOTTED BY: DGeorge
DWG NAME: 2200512-02D-OP1.dwg
TAB NAME: C2.1

BLUE RIVER, OR
BLUE RIVER DRIVE
STREETSCAPE IMPROVEMENTS
DOWNTOWN
OPTION 1

SHEET NO.

C2.1

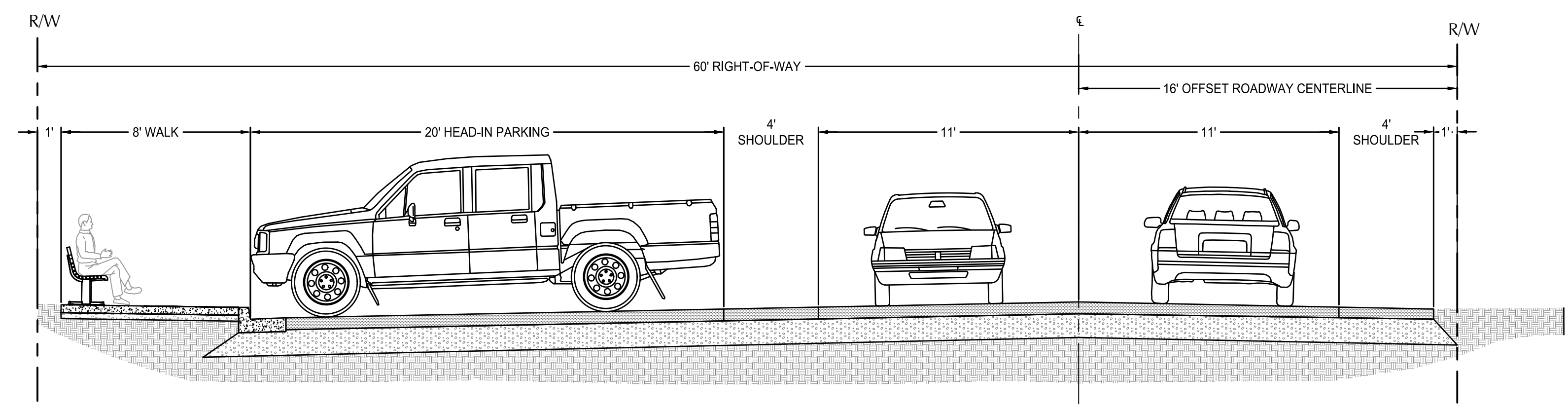

OPTION 1 SECTION
SCALE: 1" = 4'

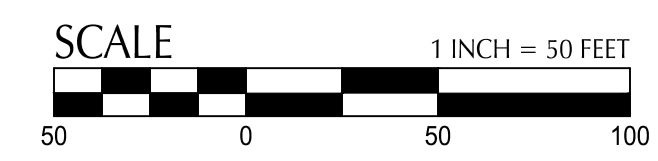
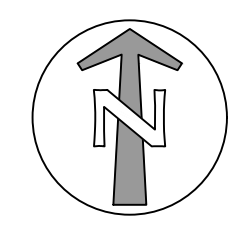

STAMP
 PRELIMINARY
 NOT FOR
 CONSTRUCTION

REVISION	DATE	DESCRIPTION

JOB No.: 2200512
 DESIGNED BY: DLG/AB
 DRAWN BY: DLG
 CHECKED BY: AB
 PLOT DATE: 4/25/23 10:39am
 PLOTTED BY: DGeorge
 DWG NAME: 2200512-02D-OP2.dwg
 TAB NAME: C2.2

BLUE RIVER, OR
 BLUE RIVER DRIVE
 STREETSCAPE IMPROVEMENTS
 DOWNTOWN
 OPTION 2

SHEET NO.

C2.2

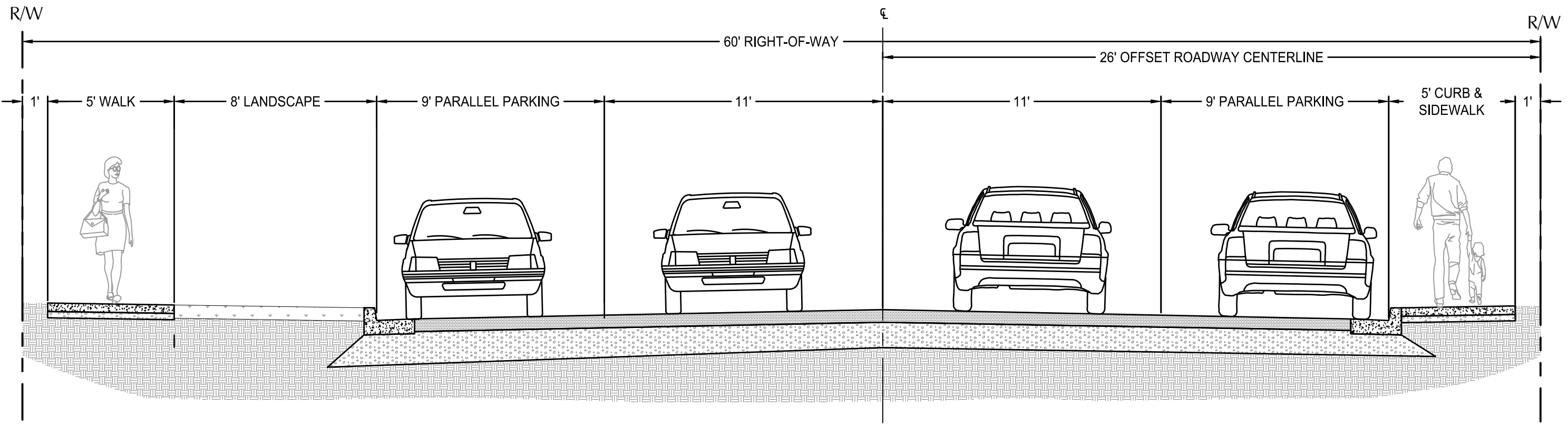
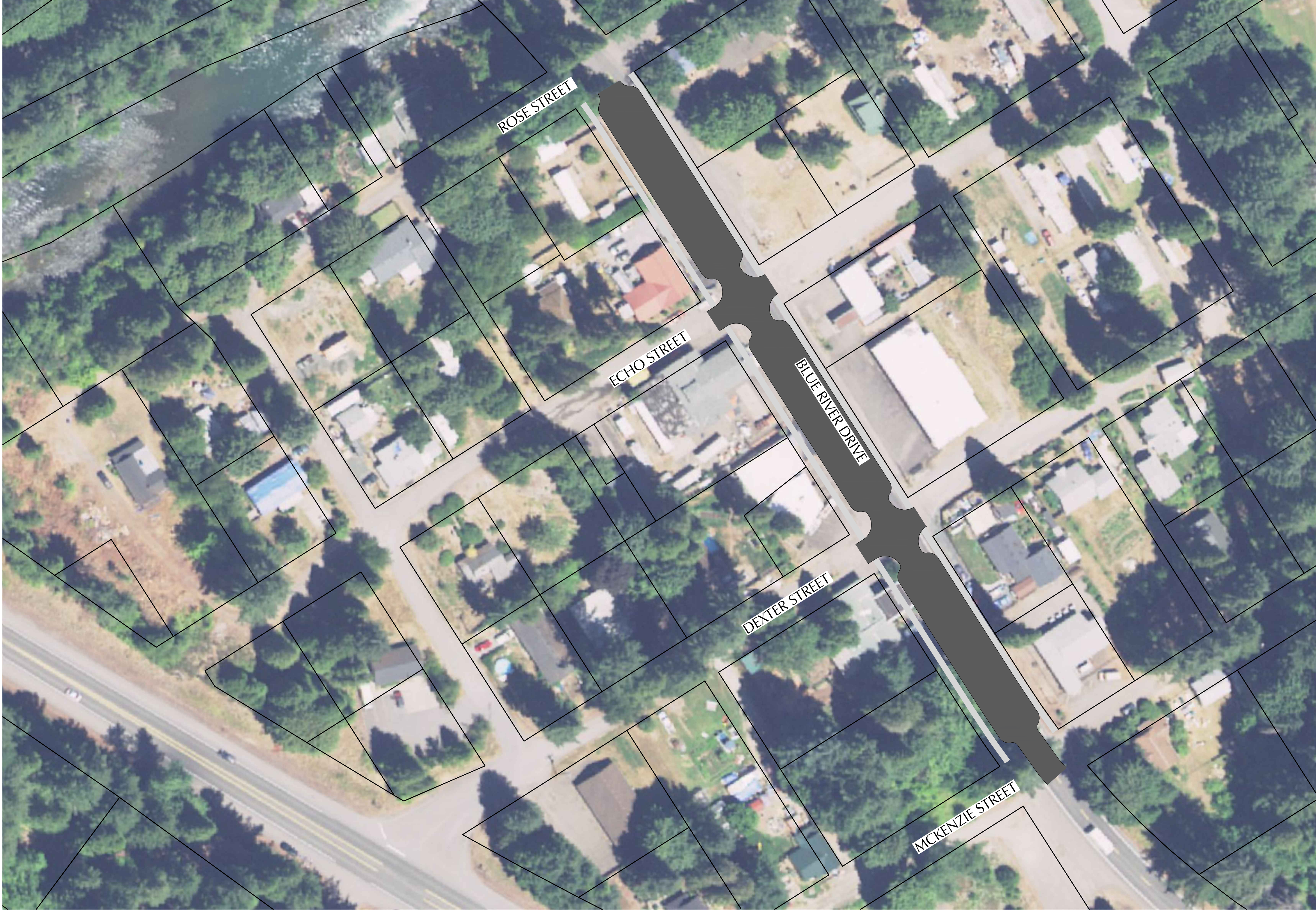

OPTION 2 SECTION
 SCALE: 1" = 4'

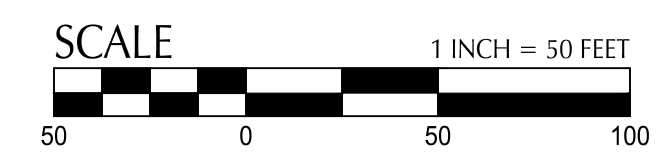
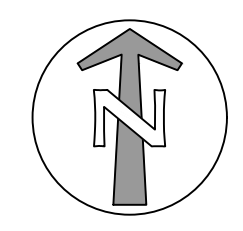

STAMP
 PRELIMINARY
 NOT FOR
 CONSTRUCTION

REVISION	DATE	DESCRIPTION

JOB No.: 2200512
 DESIGNED BY: DLG/AB
 DRAWN BY: DLG
 CHECKED BY: AB
 PLOT DATE: 4/25/23 10:39am
 PLOTTED BY: DGeorge
 DWG NAME: 2200512-02D-OP3.dwg
 TAB NAME: C2.3

BLUE RIVER, OR
 BLUE RIVER DRIVE
 STREETSCAPE IMPROVEMENTS
 DOWNTOWN
 OPTION 3

SHEET NO.

C2.3

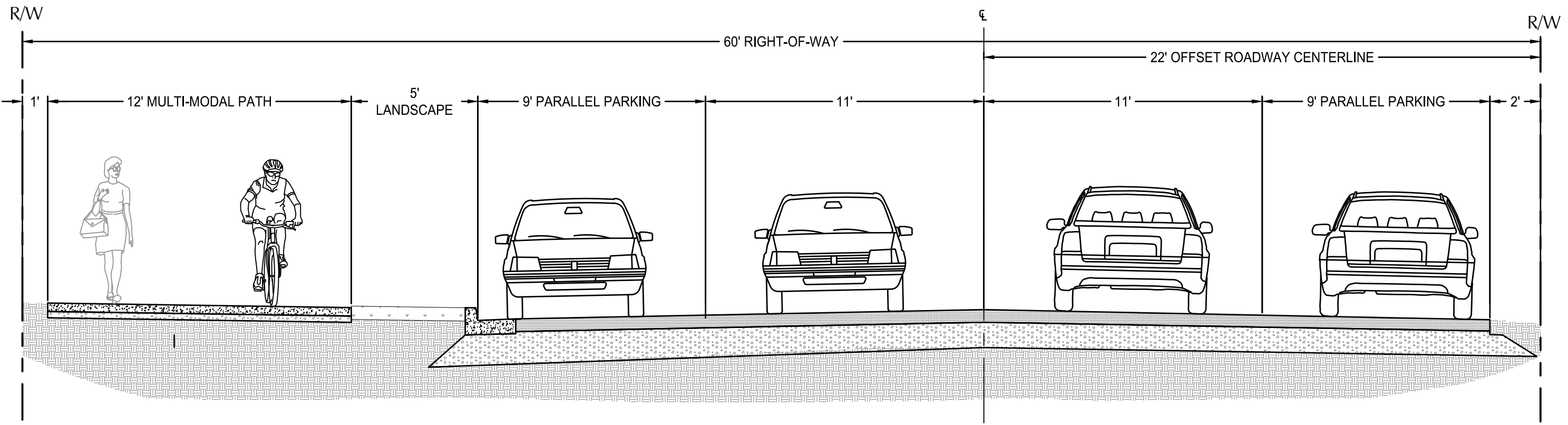
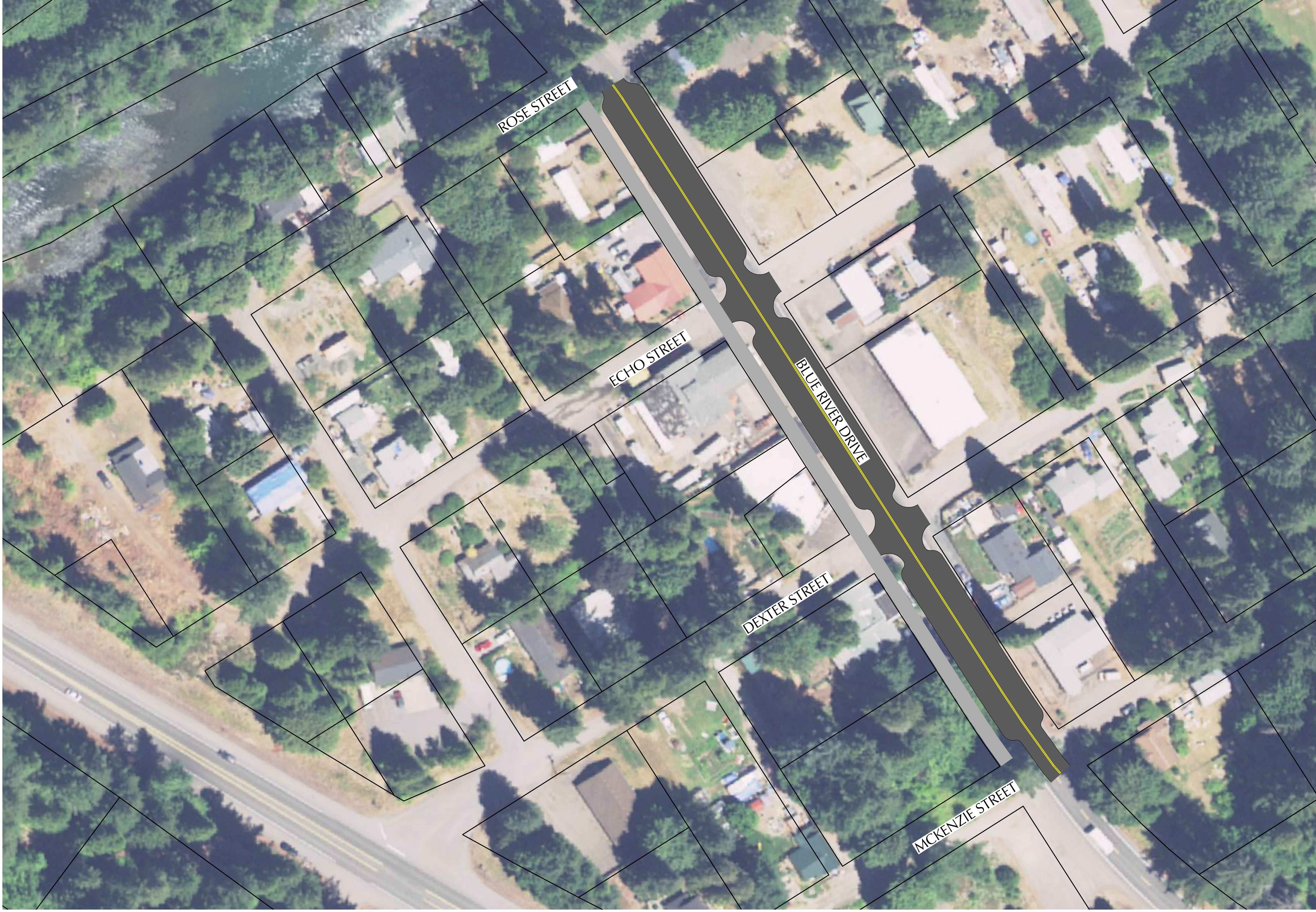

OPTION 3 SECTION
 SCALE: 1" = 4'

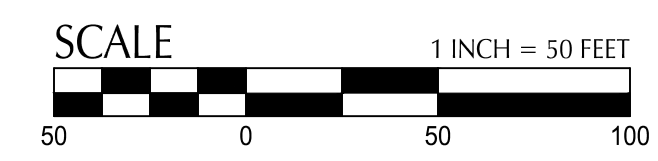
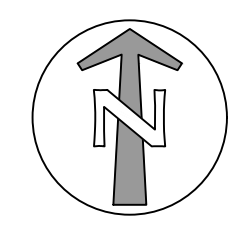

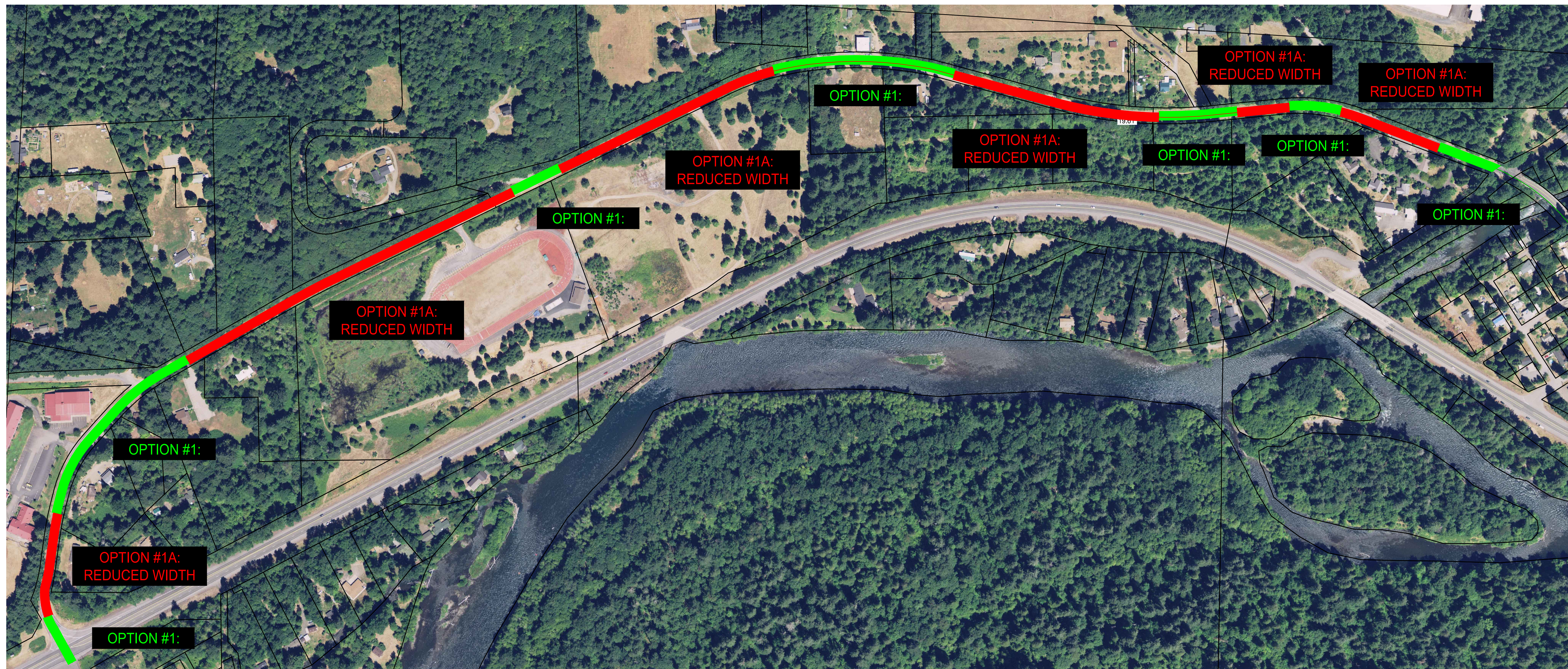

STAMP

PRELIMINARY
NOT FOR
CONSTRUCTION

REVISION	DATE	DESCRIPTION

JOB No.: 2200512
DESIGNED BY: DLG/AB
DRAWN BY: DLG
CHECKED BY: AB
PLOT DATE: 4/25/23 10:39am
PLOTTED BY: DGeorge
DWG NAME: 2200512-03W-OP1.dwg
TAB NAME: C3.1

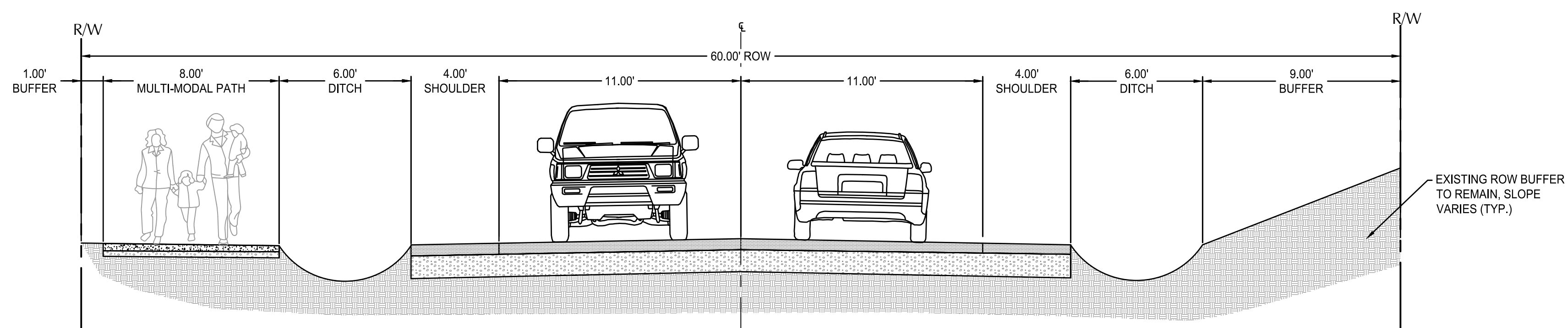

OPTION 1 SECTION
SCALE: 1" = 4'

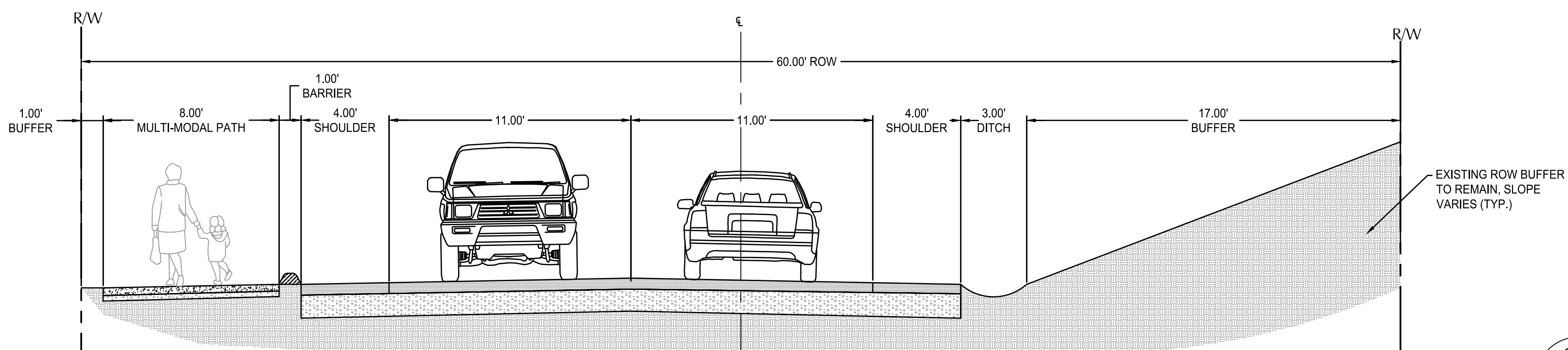

OPTION 1 SECTION REDUCED WIDTH
SCALE: 1" = 4'

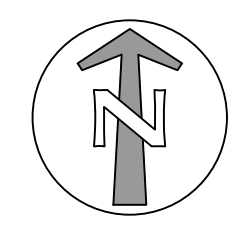

BLUE RIVER OR
BLUE RIVER DRIVE
STREETSCAPE IMPROVEMENTS
WEST BLUE RIVER DRIVE
OPTION 1

SHEET NO.

C3.1

File: O:\p\2022\200512-Blue-River-Drive\CAD\PL012200512-03W-OP1.dwg TAB:C3.1
Plotted: 4/25/23 at 10:39am By: DGeorge

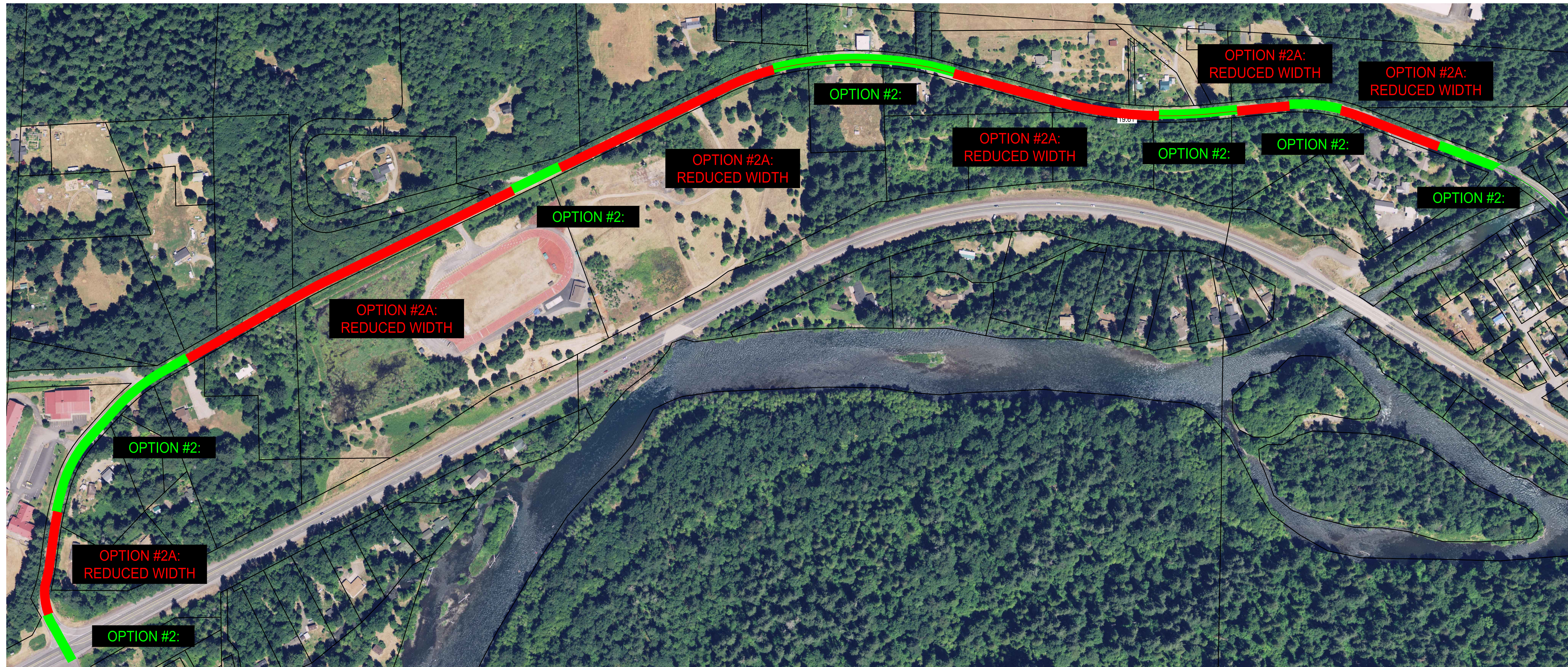

STAMP
 PRELIMINARY
 NOT FOR
 CONSTRUCTION

REVISION	DATE	DESCRIPTION

JOB No.: 2200512
 DESIGNED BY: DLG/AB
 DRAWN BY: DLG
 CHECKED BY: AB
 PLOT DATE: 4/25/23 10:39am
 PLOTTED BY: DGeorge
 DWG NAME: 2200512-03W-OP2.dwg
 TAB NAME: C3.2

BLUE RIVER OR
 BLUE RIVER DRIVE
 STREETSCAPE IMPROVEMENTS
 WEST BLUE RIVER DRIVE
 OPTION 2

SHEET NO.

C3.2

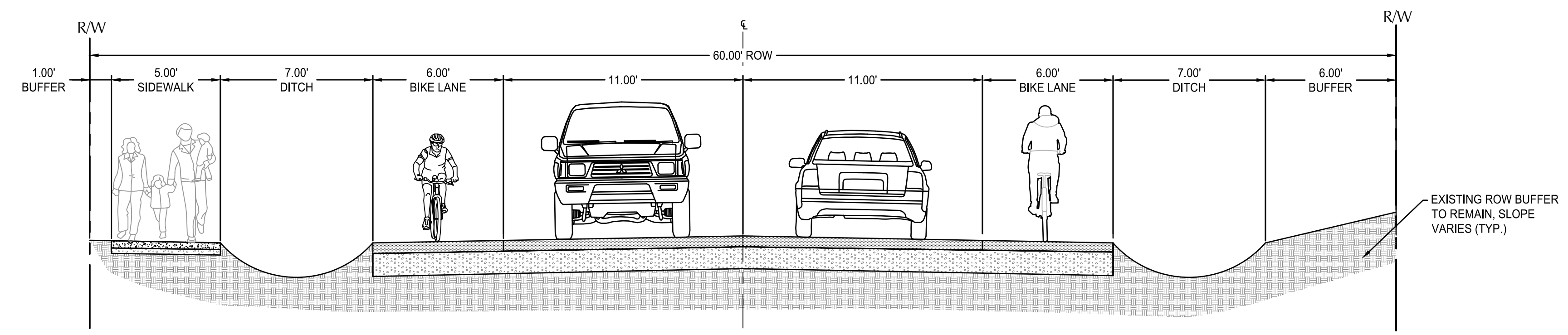

OPTION 2 SECTION
 SCALE: 1" = 4'

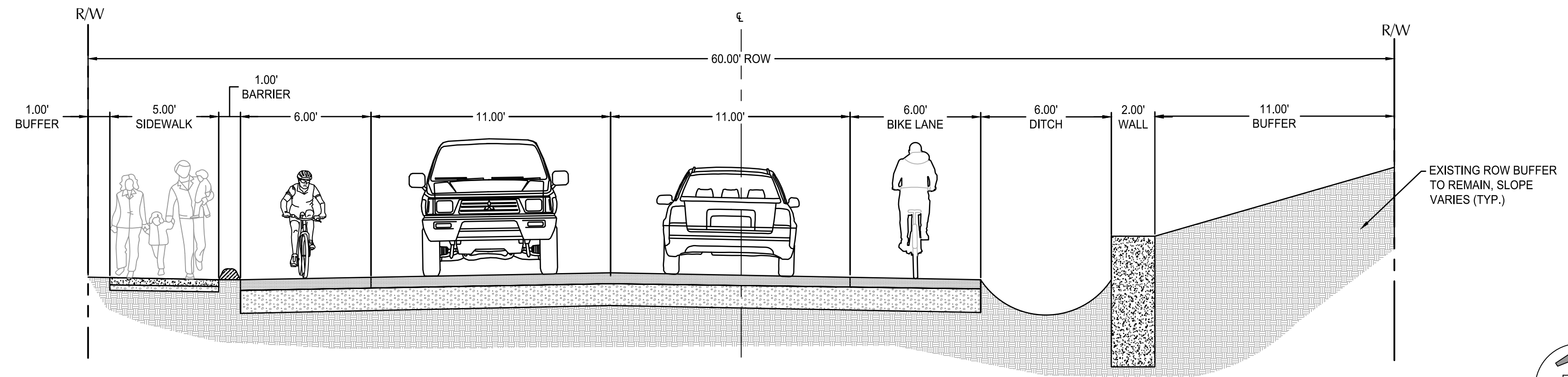

OPTION 2 SECTION REDUCED WIDTH
 SCALE: 1" = 4'

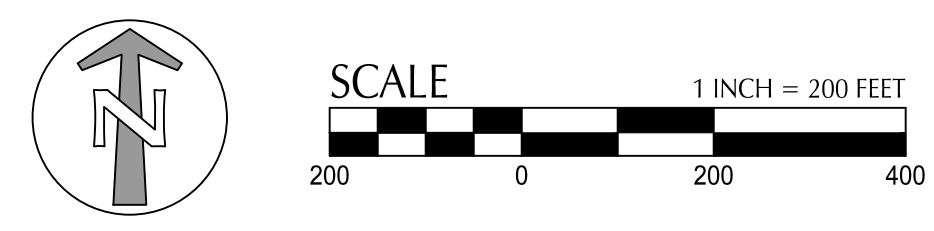

File: O:\p\2022\2200512-Blue-River-Drive\CAD\PL012200512-03W-OP2.dwg TAB: C3.2
 Plotted: 4/25/23 at 10:39am By: DGeorge

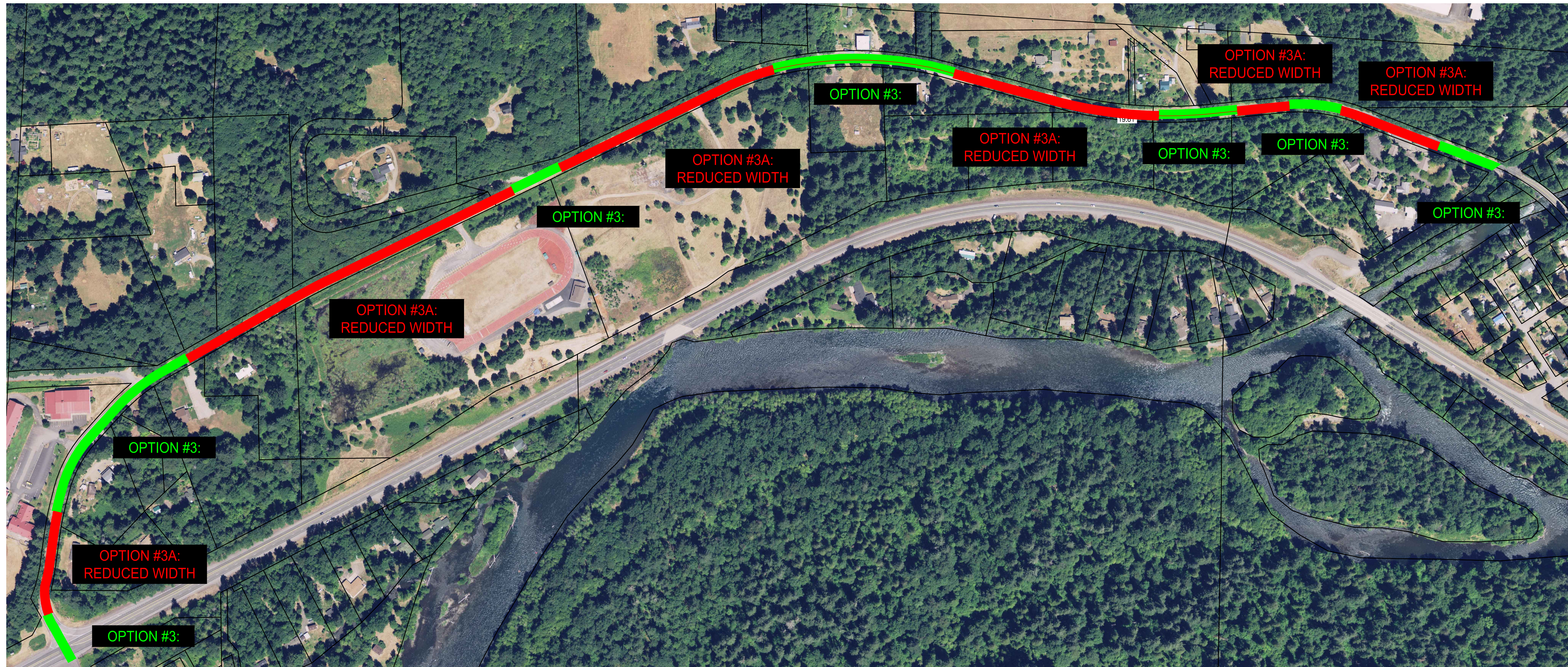

STAMP
**PRELIMINARY
NOT FOR
CONSTRUCTION**

REVISION	DATE	DESCRIPTION

JOB No.: 2200512
DESIGNED BY: DLG/AB
DRAWN BY: DLG
CHECKED BY: AB
PLOT DATE: 4/25/23 10:39am
PLOTTED BY: DGeorge
DWG NAME: 2200512-03W-OP3.dwg
TAB NAME: C3.3

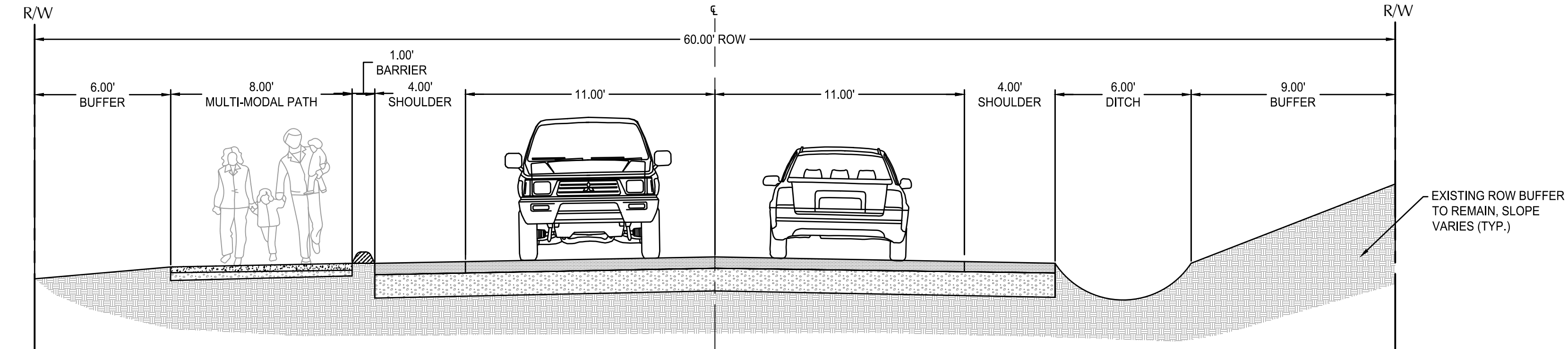

OPTION 3 SECTION
SCALE: 1" = 4'

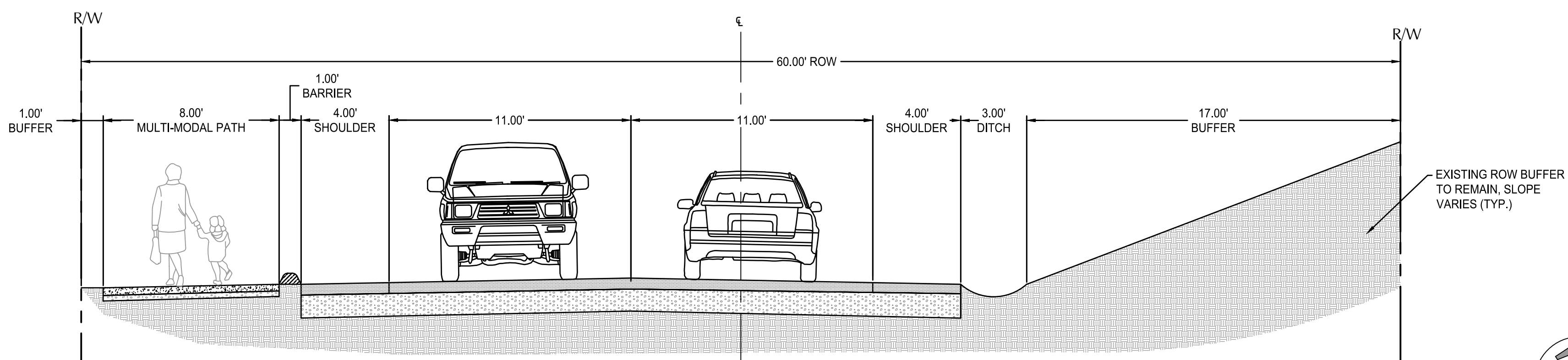

OPTION 3 SECTION REDUCED WIDTH
SCALE: 1" = 4'

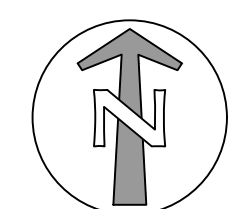

BLUE RIVER, OR
BLUE RIVER DRIVE
STREETSCAPE IMPROVEMENTS
WEST BLUE RIVER DRIVE
OPTION 3

SHEET NO.

C3.3

File: O:\p\2022\2200512-Blue-River-Drive\CAD\PL\2200512-03W-OP3.dwg TAB: C3.3
Plotted: 4/25/23 at 10:39am By: DGeorge

24x36